

Construction

Close-coupled, centrifugal pumps; electric motor with extended shaft directly connected to the pump.

NM: single-impeller

NMD: with two back-to-back impellers (with axial thrust balancing).

Connections: threaded ports ISO 228/1 (BS 2779).

NM, NMD: version with pump casing and lantern bracket in cast iron.

B-NM, B-NMD: version with pump casing and lantern bracket in bronze. (the pumps are supplied fully painted).

Applications

- For clean liquids without abrasives, which are non-aggressive for the pump materials (solids content up to 0.2%).
- For water supply.
- For heating, air-conditioning, cooling and circulation plants.
- For civil and industrial applications.
- For fire fighting applications. - For irrigation.

Operating conditions

Liquid temperature from -10 °C to +90 °C.

Ambient temperature up to 40° C.

Total suction lift up to 7 m.

Maximum permissible working pressure up to 10 bar (16 bar for pumps NMD 25/190; NMD 32/210; NMD 40/180). Continuous duty.

Motor

2-pole induction motor, 50 Hz (n = 2900 rpm).

NM, NMD: three-phase 230/400 V ± 10% up to 3 kW; 400/690 V ± 10% from 4 to 9,2 kW;

NMM, NMDM: single-phase 230 V ± 10%, with thermal protector. Insulation class F.

Protection IP 54.

Constructed in accordance with EN 60034-1.

EN 60035-1, EN 60035-2-41.

Special features on request

- Other voltages.
- Frequency 60 Hz (as per 60 Hz data sheet).
- Protection IP 55. - Special mechanical seal
- Higher or lower liquid or ambient temperatures.

Materials

Components	NM, NMD	B-NM, B-NMD
Pump casing Lantern bracket	Cast iron GJL 200 EN 1561	Bronze G-Cu Sn 10 EN 1982
Impeller	Brass P- Cu Zn 40 Pb 2 UNI 5705	
NM 17	Cast iron GJL 200 EN 1561	Bronze G-Cu Sn 10 EN 1982
Shaft	Cr steel AISI 430 Cr Ni steel AISI 303 1,1 -1,5 - 2,2 kW	Cr Ni Mo steel AISI 316
Mechanical seal	Carbon - Ceramic - NBR	

Coverage chart n ≈ 2900 rpm

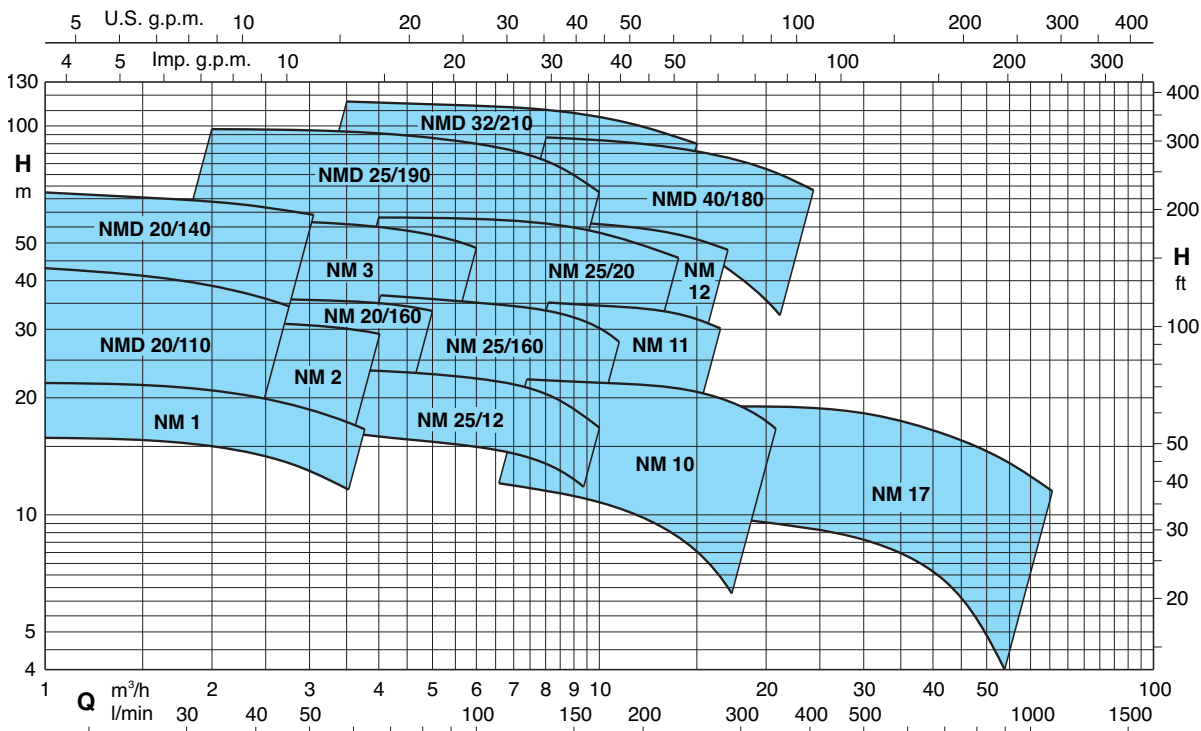

Performance n ≈ 2900 rpm

	NM	P ₂		Q m³/h																
		kW	HP		1 1,2 1,5 1,89 2,4 3 3,6 4,2 4,8 5,4 6 6,6 7,5 8,4															
						l/min 16 20 25 31,5 40 50 60 70 80 90 100 110 125 140														
	NM 1/AE ●	0,37	0,5	H m	22	21,6	21,3	20,9	20,3	19,4	18,1	16,3								
	NM 2/B/A ●	0,55	0,75		27	26,5	26	25,5	25	24	23	22	20							
	NM 2/S/A ●	0,55	0,75		31	30,5	30	29	27,5	25,5	23,5	20	16							
	NM 2/A/A ●	0,75	1		33,5	33	32,5	32	31,5	30,5	29,5	28,5	27	26	24					
	NMM 3/CE	1,1	1,5			37,5	37,5	37	36,5	36	35	34	32							
	NM 3/CE	1,1	1,5			37,5	37,5	37	36,5	36	35	34	32	30,5*	28,5*					
	NMM 3/BE	1,5	2			42	42	41	41,5	40,5	40	39	37	35*	32*					
	NM 3/BE	1,5	2			47	47	46,5	46	45,5	45	44	43	41,5*	40*	37,5*	33*	26*		
	NM 3/AE	2,2	3			56	55,5	55,5	55	54,5	53,5	52,5	51,5	50*	48*	46*	42*	36*		

B-NM B-NMD	NM NMD	P ₂		Q m³/h																
		kW	HP		1 1,2 1,5 1,89 2,4 3 3,6 4,2 4,8 5,4 6 6,6 7,5 8,4															
						l/min 16 20 25 31,5 40 50 60 70 80 90 100 110 125 140														
B-NMD 20/110B/A ●	NMD 20/110B/A ●	0,45	0,6	H m	33	32	31	29	26,5	23	18									
B-NMD 20/110Z/A ●	NMD 20/110Z/A ●	0,55	0,75		37	36	35	33	30,5	27,5	23	18*								
B-NMD 20/110A/A ●	NMD 20/110A/A ●	0,75	1		43	42	40,5	39	36,5	33	29	25*								
B-NMDM 20/140BE	NMDM 20/140BE	1,1	1,5		52	51,5	51	50	48,5	47	45									
B-NMD 20/140BE	NMD 20/140BE	1,1	1,5		53	52,5	52	51	50	48	46	43,5	40							
B-NMDM 20/140AE	NMDM 20/140AE	1,5	2		57,5	57	56,5	55,5	54	51,5	49	46	43	40	36					
B-NMD 20/140AE	NMD 20/140AE	1,5	2		67	66,5	66	64,5	63	61,5	59	57	53,5	50	46					
B-NM 20/160BE ●	NM 20/160BE ●	0,75	1					30,5	30	29,5	28,5	27,5	26,5	25,5	24	22*				
B-NM 20/160AE ●	NM 20/160AE ●	1,1	1,5					36	35,5	35	34,5	33,5	32	30,5	29	27*				

B-NM B-NMD	NM NMD	P ₂		Q m³/h																
		kW	HP		2,4 3 3,6 4,8 6 6,6 7,5 8,4 9,6 10,8 12 13,2 15 16,8															
						l/min 40 50 60 80 100 110 125 140 160 180 200 220 250 280														
B-NM 25/12B/A ●	NM 25/12B/A ●	0,55	0,75	H m	20	19,9	19,8	19,3	18,5	18	17,3	16,3	15*	13,2*	11*					
B-NM 25/12A/A ●	NM 25/12A/A ●	0,75	1		23,5	23,4	23,3	22,9	22,1	21,7	20,9	20	18,7*	17,1*	15,2*					
B-NM 25/160BE ●	NM 25/160BE ●	1,1	1,5			31	30,7	30	28,5	28	27	26	23							
B-NM 25/160AE ●	NM 25/160AE ●	1,5	2			36,5	36,2	35,5	34,5	34	33,5	32,5	31	28,5*	26*					
B-NM 25/200BE	NM 25/20BE	2,2	3			42,5	42	41	40	39,5	38,5	37,5	36	33*	29*					
B-NM 25/200AE	NM 25/20AE	3	4			50	49,7	49	48	47,5	47	46,5	45,5	44*	42*	39*				
B-NM 25/200SE	NM 25/20SE	4	5,5			59	58,5	58	57,5	57	56,5	55,5	54,5	53	51,5	49*	44,5*	37*		
B-NMD 25/190CE	NMD 25/190CE	2,2	3			62	60,5	59	55,5	51	48,5	44	38*							
B-NMD 25/190BE	NMD 25/190BE	3	4			76	75	74	70	66	64	60	54	46*						
B-NMD 25/190AE	NMD 25/190AE	4	5,5			98	97	96	93,5	90	88	84	79	70*						

	NM	P ₂		Q m³/h																
		kW	HP		6,6 7,5 8,4 9,6 10,8 12 13,2 15 16,8 18,9 21 24 27 30															
						l/min 110 125 140 160 180 200 220 250 280 315 350 400 450 500														
	NM 10/FE ●	0,55	0,75	H m	12,5	12,5	12	11,5	11	10	9	7,5								
	NM 10/DE ●	0,75	1		18	18	17,5	17	16,5	16	15,5	14								
	NM 10/AE ●	1,1	1,5		23	23	22,5	22	21,5	21	20,5	19								
	NM 10/SE ●	1,5	2		23,5	23,5	23	22,5	22	21,5	21	20,5	19*	18,5*	16,5*	13*				
	NMM 11/BE	1,5	2		26,5	25,5	25	24	23	22,5	21,5	19,5	17,5							
	NM 11/BE	1,5	2		29,5	29,5	29	28,5	27,5	27	26	25*	22,5*							
	NM 11/AE	2,2	3		35,5	35,5	35	34,5	34	33,5	33	32*	30*							
	NM 12/DE	2,2	3		38	37,5	37	36	35	33,5	32									
	NM 12/CE	3	4		45	44,5	44	43,5	42,5	41	40	38	36*							
	NM 12/AE	4	5,5		57,5	57	56	55,5	55	54,5	53,5	51,5	49*							

Performance n ≈ 2900 rpm

1

B-NMD	NMD	P ₂		Q m ³ /h l/min	H															
		kW	HP		5,4	6	6,6	7,5	8,4	9,6	10,8	12	13,2	15	16,8	18,9	21	24		
B-NMD 32/210DE	NMD 32/210DE	4	5,5	H m	71	69	67,5	65	62,5	58	53	46	37*							
B-NMD 32/210CE	NMD 32/210CE	5,5	7,5		84	83	82	81	79	76	73	69	64*	54*						
B-NMD 32/210BE	NMD 32/210BE	7,5	10		104	103	102	100	98	95	92	88	84*	76*						
B-NMD 32/210AE	NMD 32/210AE	9,2	12,5		114	113	112	110	108	105	103	99	96*	90*						
B-NMD 40/180DE	NMD 40/180DE	4	5,5					60	59,5	57	56	53	51,5	48	44	39	34*	25*		
B-NMD 40/180CE	NMD 40/180CE	5,5	7,5					69	68	67	66	64,5	63	60	57	53	48*	40*		
B-NMD 40/180BE	NMD 40/180BE	7,5	10					87	86	85	84	82,5	81	78	75	71	66*	59*		
B-NMD 40/180AE	NMD 40/180AE	9,2	12,5					94	93	92	91	89,5	88	85	82	78	74*	67*		

B-NM	NM	P ₂		Q m ³ /h l/min	H															
		kW	HP		21	24	27	30	33	37,8	42	48	54	60	66	75	84	96		
B-NM 17/HE●	NM 17/HE●	1,1	1,5	H m	9,5	9,2	9	8,6	8,2	7,5	6,7	5,5	3,5*							
B-NM 17/GE●	NM 17/GE●	1,5	2		12	11,7	11,5	11,2	11	10,3	9,7	8,5	7*	4*						
B-NM 17/FE	NM 17/FE	2,2	3			16	16	15,5	15	14,5	14	13	11,5*	10*	8*					
B-NM 17/DE	NM 17/DE	3	4					18	18	17,5	17	16,5	15,5	14*	13*	11,5*				

NM, NMD Standard construction.
B-NM, B-NMD Bronze construction.

P₂ Rated motor power output.
H Total head in m.

● With single-phase motor = NMM - NMDM.
* Maximum suction lift 1-2 m.
Tolerances according to ISO 9906, annex A.

Rated currents

P1 kW	P2		230 V 1~ IN A	IA/IN	P2		230 V Δ / 400 V Y			IA/IN
	kW	HP			kW	HP	IN A	IN A	IN A	
0,62	0,37	0,5	3	2,7	0,37	0,5	2,3	1,3		3,8
0,72	0,45	0,6	3,6	2,9	0,45	0,6	2,3	1,3		3,5
0,91	0,55	0,75	4,5	3,1	0,55	0,75	3	1,7		4,3
1,2	0,75	1	5,8	3	0,75	1	4	2,3		5,2
1,6	1,1	1,5	7,4	3	1,1	1,5	5	2,9		5,3
2	1,5	2	9,2	3,8	1,5	2	7,5	4,3		5,8
					2,2	3	9,15	5,3		6
					3	4	11,5	6,6		9
					4	5,5		9,6	5,5	9,3
					5,5	7,5		12	7	8,3
					7,5	10		16	9,2	8,8
					9,2	12,5		18,5	10,7	8,3

P1 Maximum power input.
P2 Rated motor power output.
IA/IN D.O.L. starting current / Nominal current

Characteristic curves $n \approx 2900$ rpm

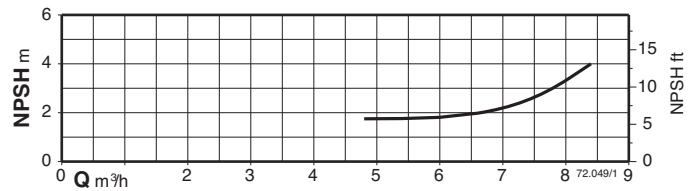
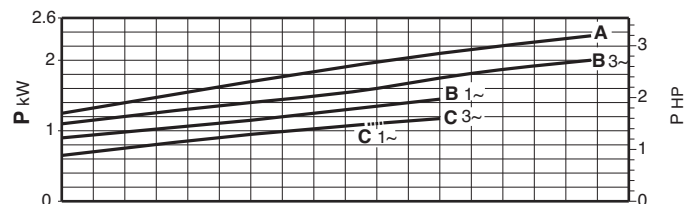
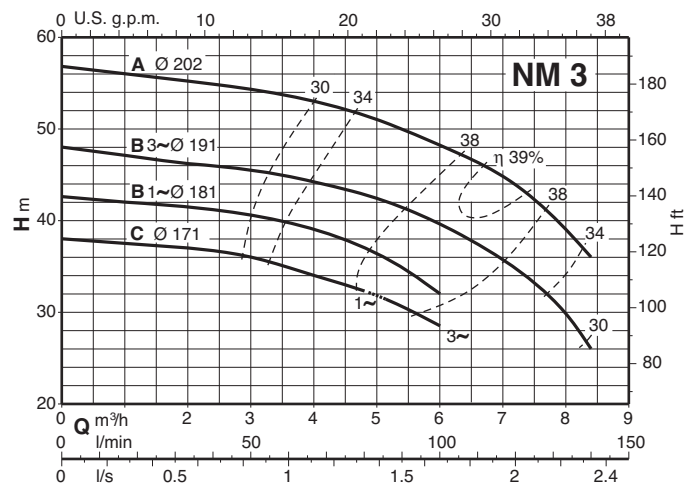
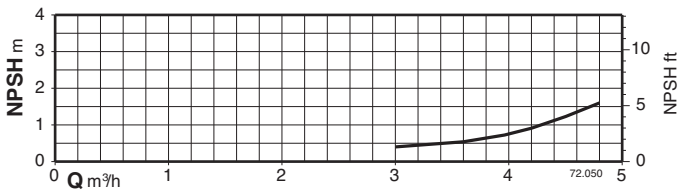
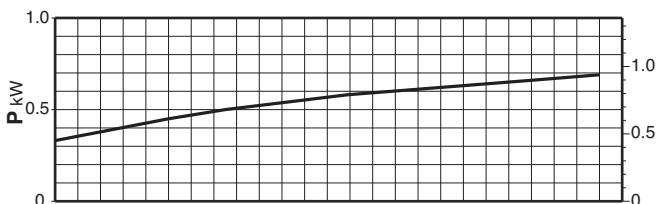
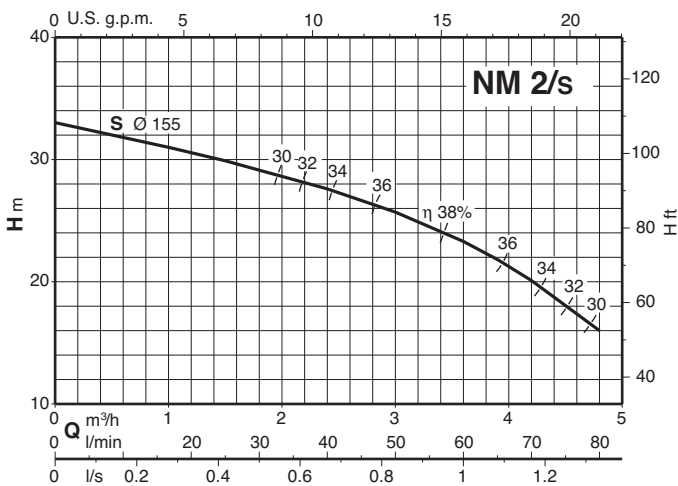
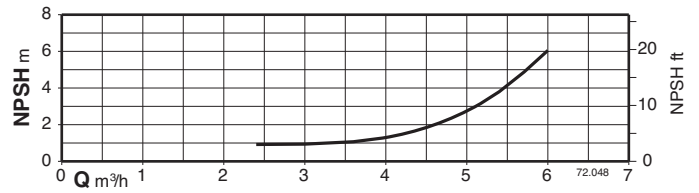
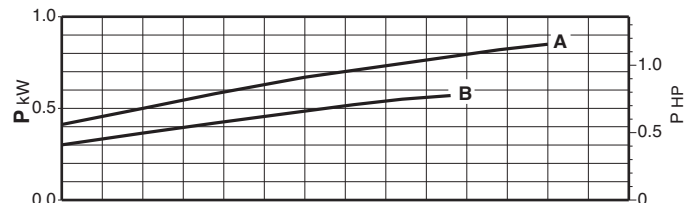
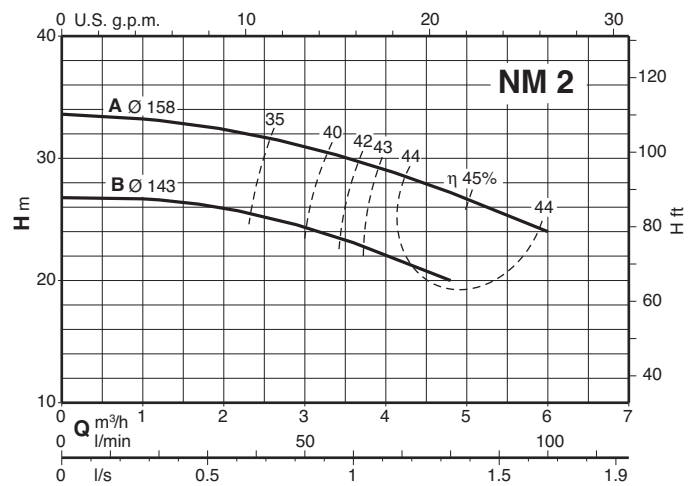
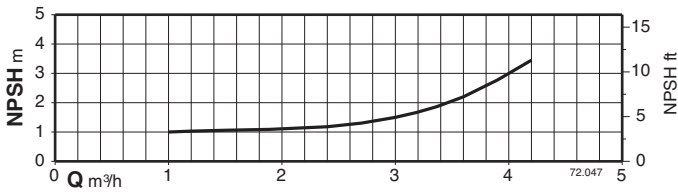
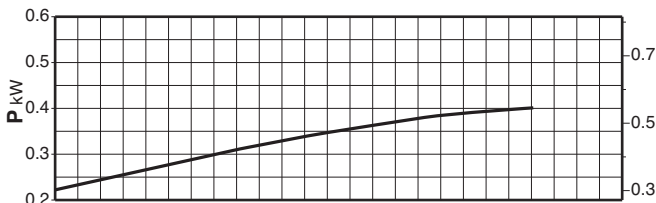
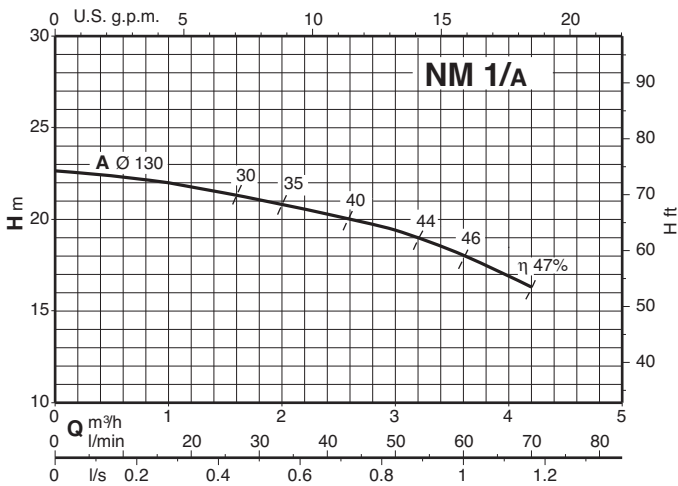

Characteristic curves $n \approx 2900$ rpm

1

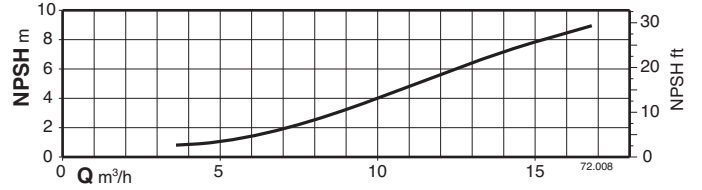
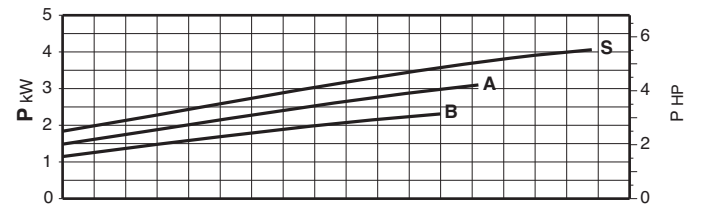
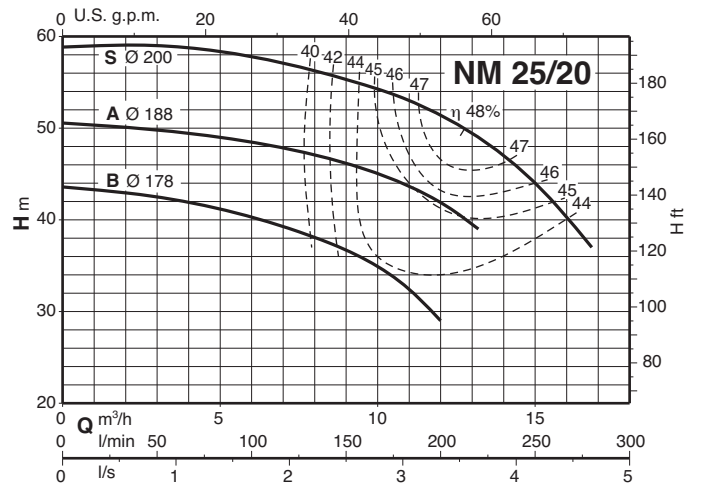
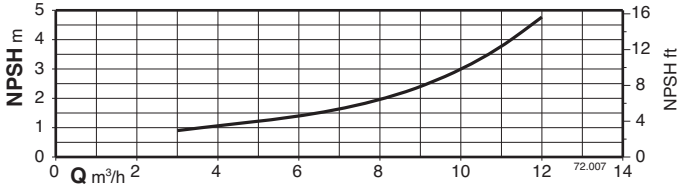
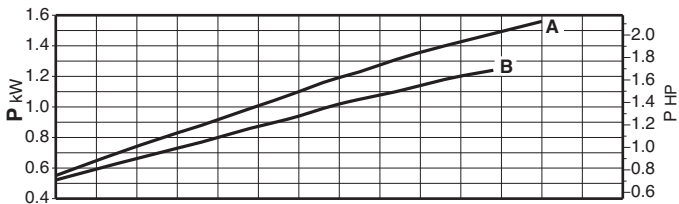
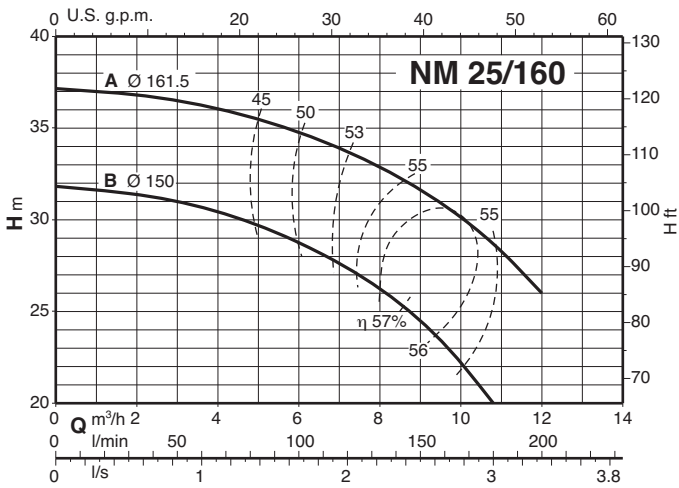
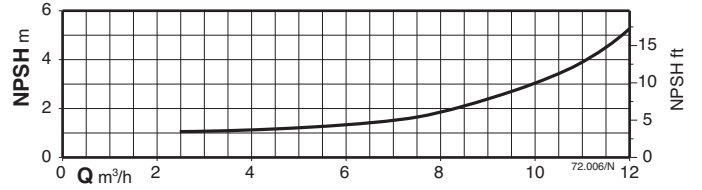
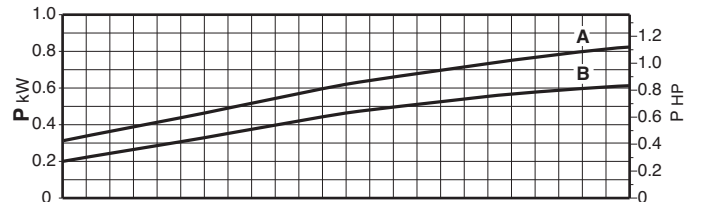
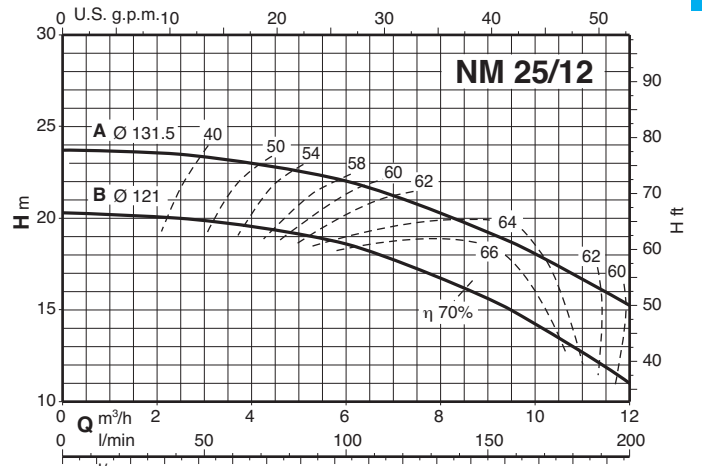
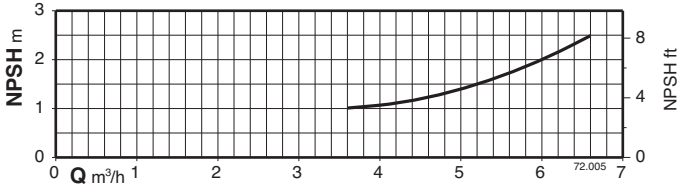
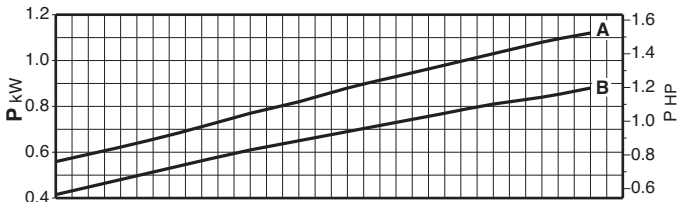
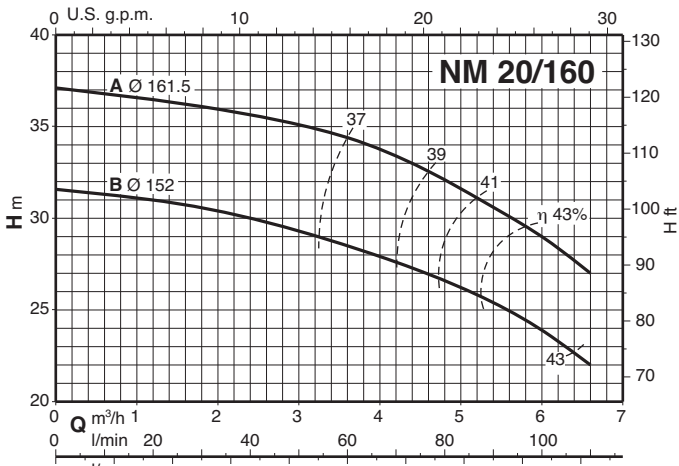

Characteristic curves $n \approx 2900$ rpm

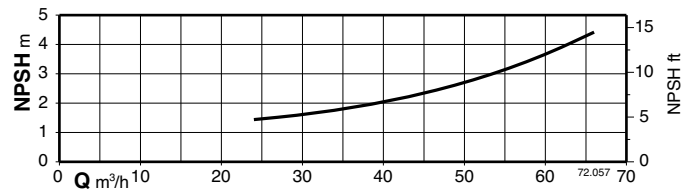
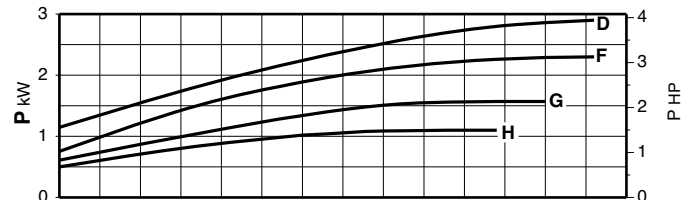
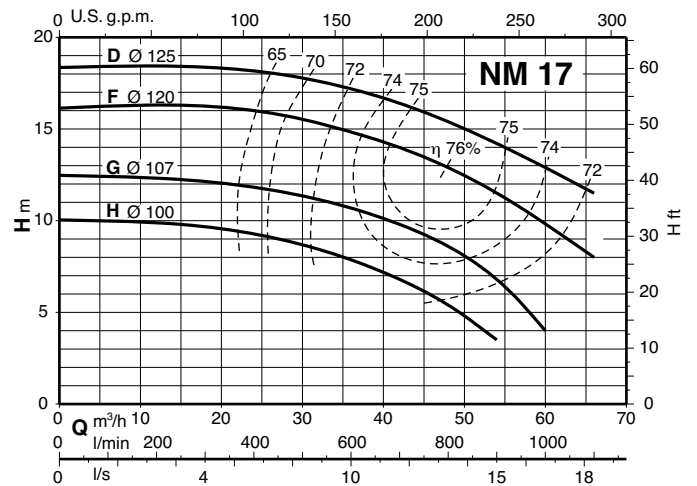
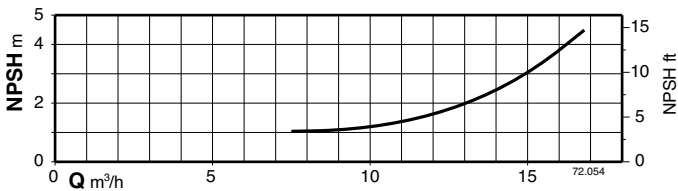
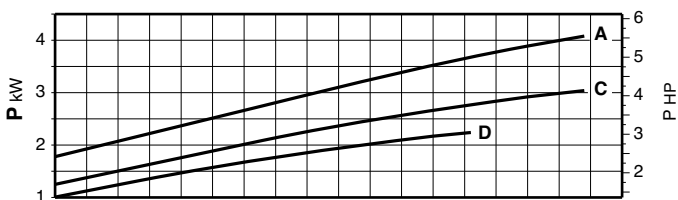
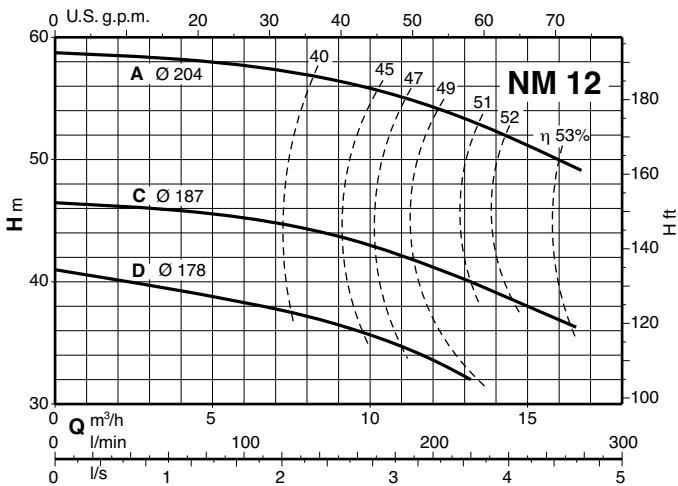
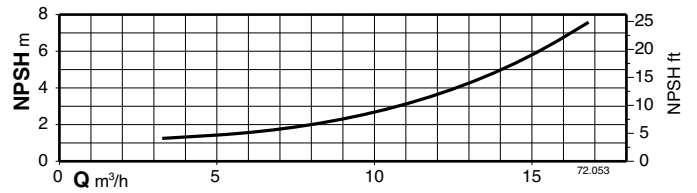
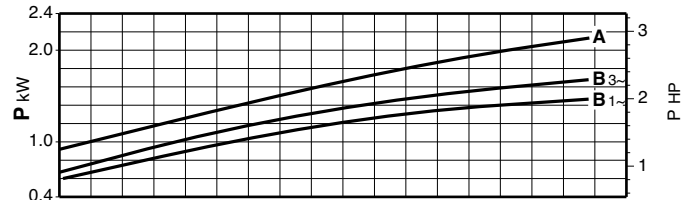
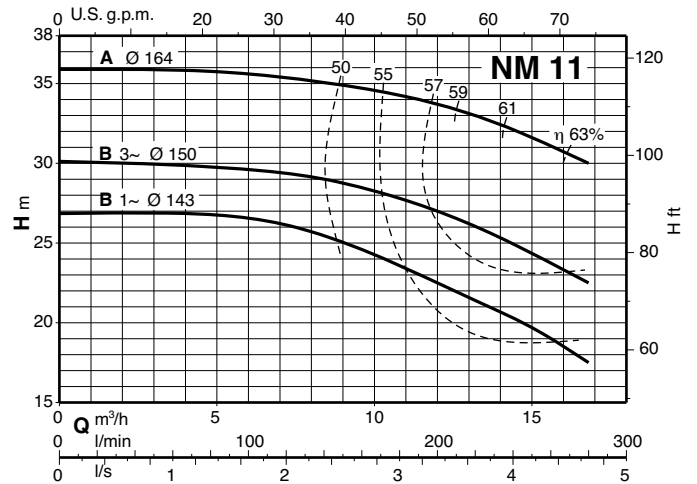
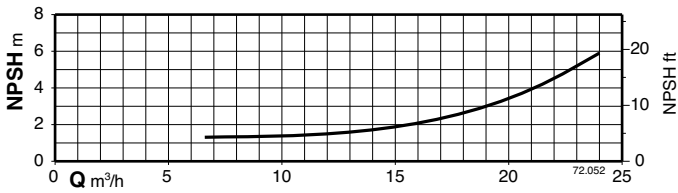
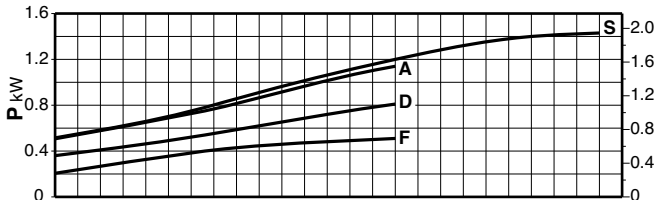
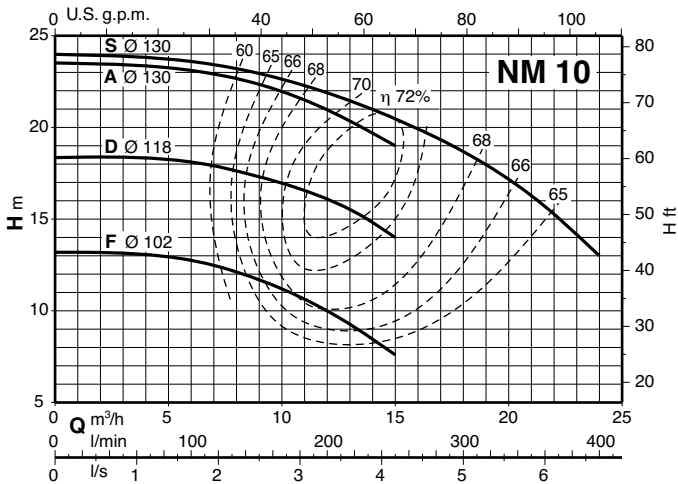

Characteristic curves $n \approx 2900$ rpm

1

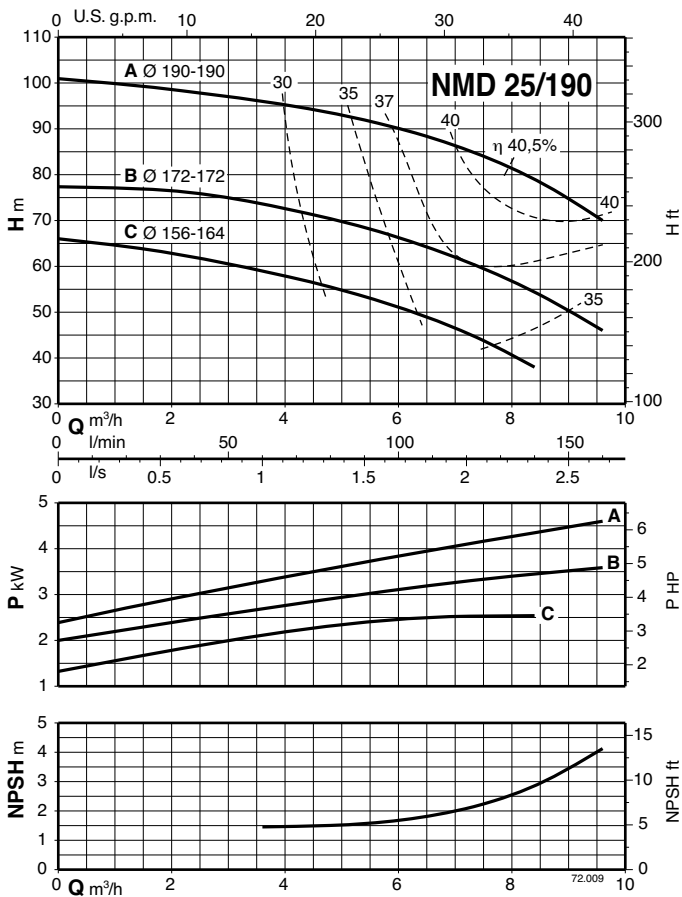
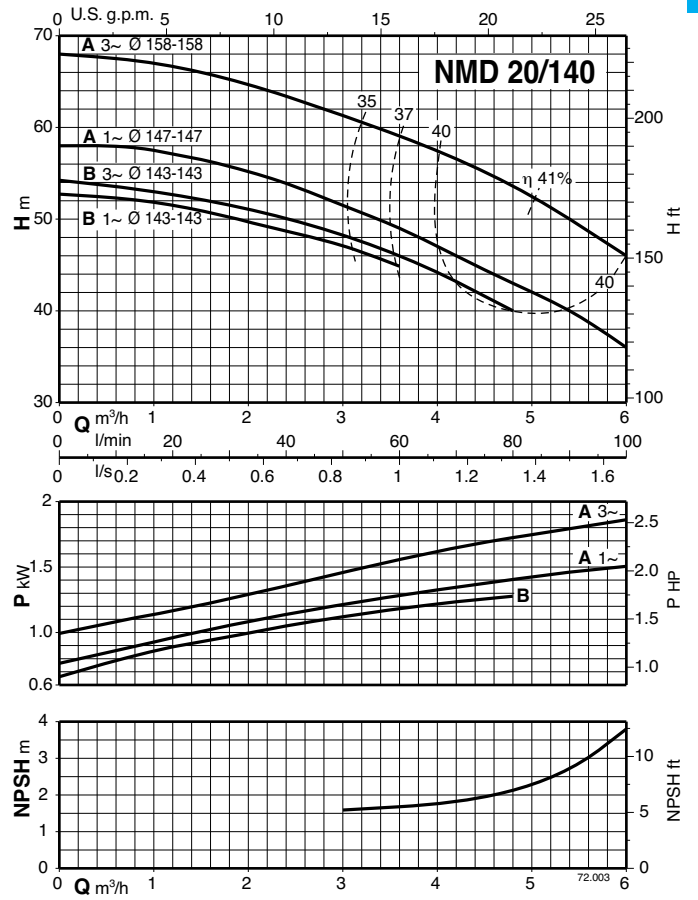
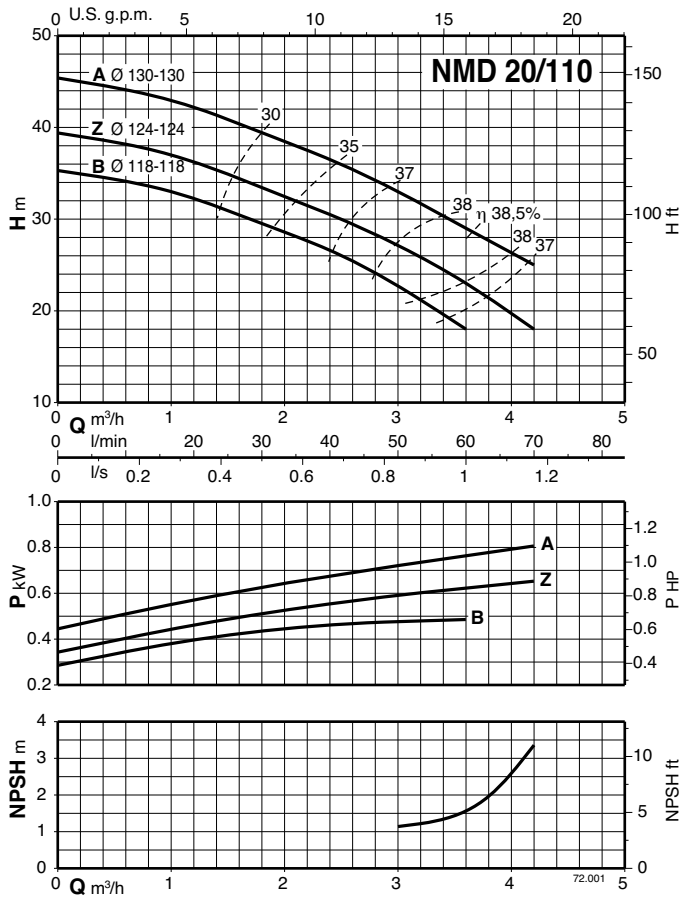

Characteristic curves $n \approx 2900$ rpm

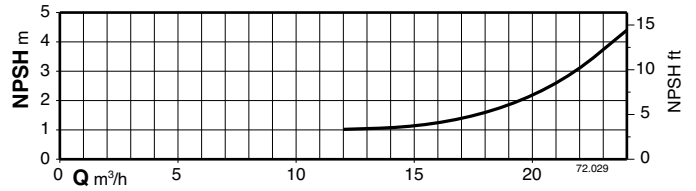
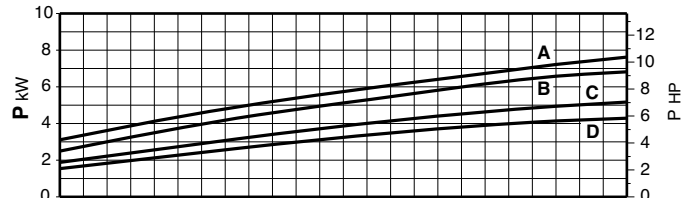
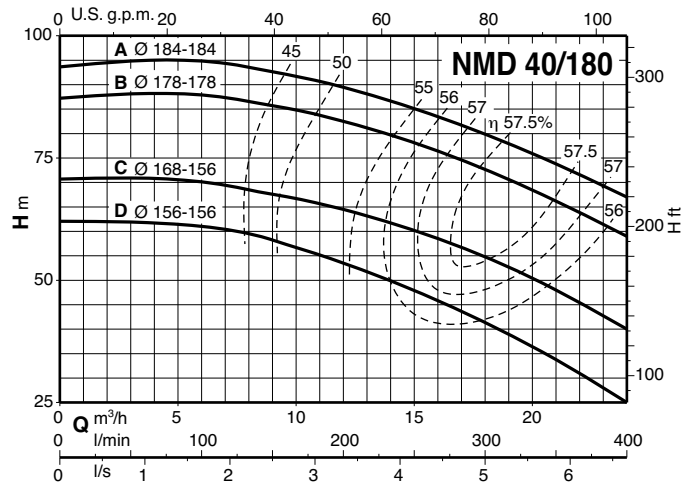
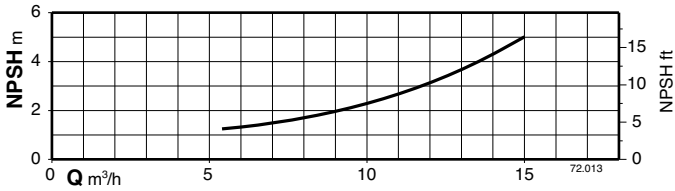
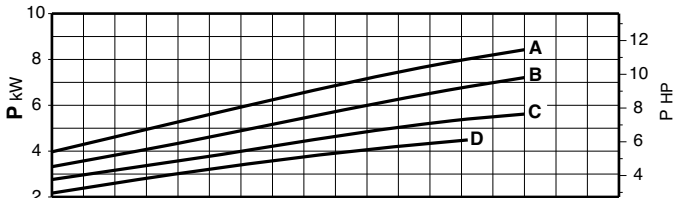
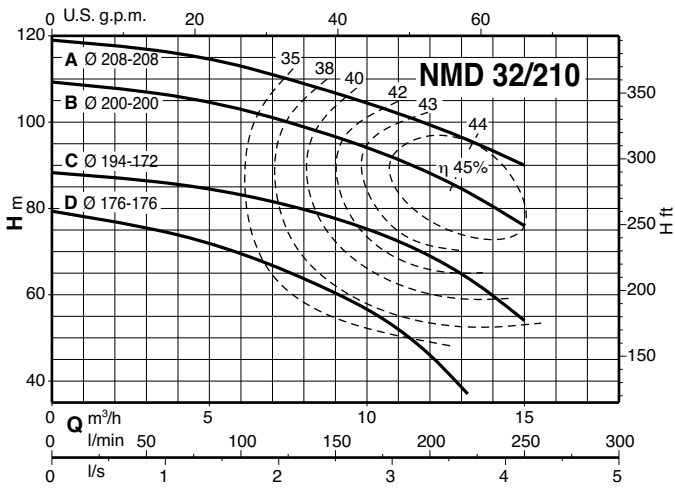

Dimensions and weights

1

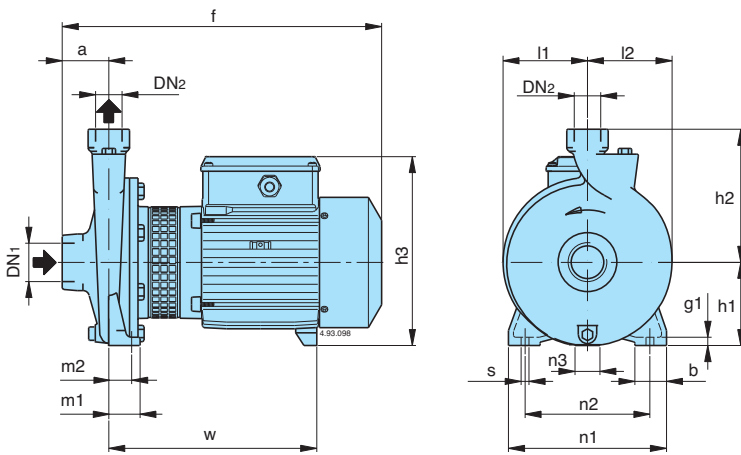

TYPE	NMM kg	NM kg	B-NM kg
NM 1/AE	8,7	8,6	
NM 2/B/A	14	13,1	
NM 2/S/A	14,2	13,3	
NM 2/A/A	15,1	14,2	
NM 3/CE	24	22,9	
NM 3/BE	26	25,1	
NM 3/AE		26,1	
B- NM 20/160BE	19,9	18,4	21
B- NM 20/160AE	20,7	19,7	22,5
B- NM 25/12B/A	13,2	12,3	13,5
B- NM 25/12A/A	14,2	13,3	14,5
B- NM 25/160BE	20,4	19,7	22,8
B- NM 25/160AE	22,5	21,5	24
NM 25/20BE		28,6	
NM 25/20AE		37,9	
NM 25/20SE		41,7	
B- NM 25/200BE			32,7
B- NM 25/200AE			40,7
B- NM 25/200SE			44,7
NM 10/FE	19,3	18,5	
NM 10/DE	19,4	18,8	
NM 10/AE	20,2	19,3	
NM 10/SE	22,1	21,5	
NM 11/BE	24,7	24,1	
NM 11/AE		25,1	
NM 12/DE		30,5	
NM 12/CE		39	
NM 12/AE		43	
B- NM 17/HE	23	22,2	29,2
B- NM 17/GE	24,2	23,2	30,2
B- NM 17/FE		25,2	32,2
B- NM 17/DE		33,2	40,2

B-NM	NM	DN ₁ ISO 228	DN ₂	mm															
				a	f	h ₁	h ₂	h ₃	m ₁	m ₂	n ₁	n ₂	n ₃	b	s	l ₁	l ₂	w	g ₁
	NM 1/AE	G 1	G 1	40	261	80	132	176	40	32	170	140	17	35	9,5	77	81	171	10
	NM 2/A/A-S/A-B/A	G 1	G 1	45	305	95	150	207	40	32	190	160	17	35	9,5	87	90	203	10
	NM 3/AE-BE-CE	G 1	G 1	50	375	112	180	240	55	43	245	205	37	45	11,5	110	113	244	12
B- NM 20/160AE-BE	NM 20/160AE-BE	G 1 1/4	G 3/4	53	375	100	150	228	37,5	27,5	190	150	30	38	9,5	102	102	246	10
B- NM 25/12A/A-B/A	NM 25/12A/A-B/A	G 1 1/2	G 1	56	313	90	140	199	37,5	27,5	170	130	9	38	9,5	85	88	195	10
B- NM 25/160AE-BE	NM 25/160AE-BE	G 1 1/2	G 1	56	380	100	160	228	37,5	27,5	190	150	30	38	9,5	102	102	246	10
	NM 25/20BE	G 1 1/2	G 1	63	393	125	180	253	45	32,5	245	200	49	45	11,5	125	125	251	11
	NM 25/20AE-SE	G 1 1/2	G 1	63	460	125	180	253	45	32,5	245	200	42	45	11,5	125	125	295	11
B- NM 25/200BE		G 1 1/2	G 1	63	405	125	180	253	45	32,5	245	200	49	45	11,5	125	125	263	11
B- NM 25/200AE-SE		G 1 1/2	G 1	63	460	125	180	253	45	32,5	245	200	42	45	11,5	125	125	295	11
	NM 10/SE-AE-DE-FE	G 2	G 1 1/4	63	382	100	150	228	50	35	190	140	30	50	13	90	97	239	14
	NM 11/AE-BE	G 2	G 1 1/4	70	400	112	170	240	50	35	210	160	37	50	15	103	110	247	14
	NM 12/DE	G 2	G 1 1/4	70	400	132	190	260	50	35	240	190	47	50	15	125	127	247	14
	NM 12/AE-CE	G 2	G 1 1/4	70	470	132	190	260	50	35	240	190	45	50	15	125	127	300	14
B- NM 17/FE- GE-HE	NM 17/FE- GE-HE	G 2 1/2	G 2 1/2	80	417	112	160	240	50	35	210	160	37	50	14	96	113	257	14
B- NM 17/DE	NM 17/DE	G 2 1/2	G 2 1/2	80	480	112	160	240	50	35	210	160	20	50	14	96	113	295	14

Dimensions and weights

NMD 20/110

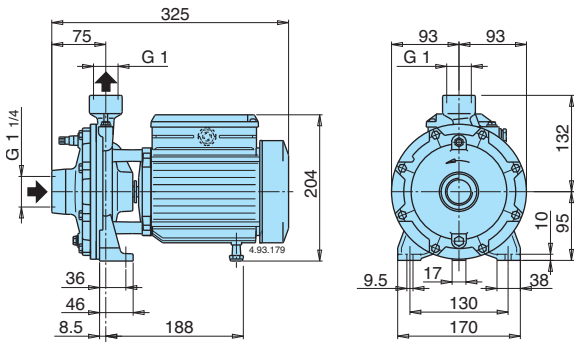

TYPE	NMDM kg	NMD kg	B-NMD kg
B- NMD 20/110B/A	13	12,1	13,4
B- NMD 20/110Z/A	14	13	14,2
B- NMD 20/110A/A	15,1	14,2	17,4

NMD 20/140 NMD 25/190

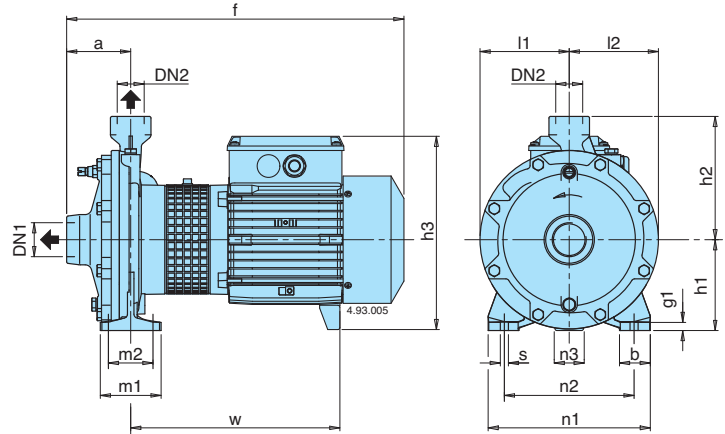

TYPE	NMDM kg	NMD kg	B-NMD kg
B- NMD 20/140BE	23,9	22,7	25,2
B- NMD 20/140AE	25,2	24,8	27,6
B- NMD 25/190CE		39	42,7
B- NMD 25/190BE		46,7	51
B- NMD 25/190AE		51	55

B-NMD	NMD	DN1 ISO 228	DN2	mm															
				a	f	h1	h2	h3	m1	m2	n1	n2	n3	b	s	l1	l2	w	g1
B- NMD 20/140AE-BE	NMD 20/140AE-BE	G 1 1/4	G 1	80	417	112	152	243	75	55	200	160	37	38	9,5	110	110	256	10
B- NMD 25/190CE	NMD 25/190CE	G 1 1/2	G 1		447								50					274	
B- NMD 25/190BE	NMD 25/190BE			97	500	140	180	268	100	70	240	190	49	50	14	133	133	306	13
B- NMD 25/190AE	NMD 25/190AE				500									49					306

NMD 32/210 NMD 40/180

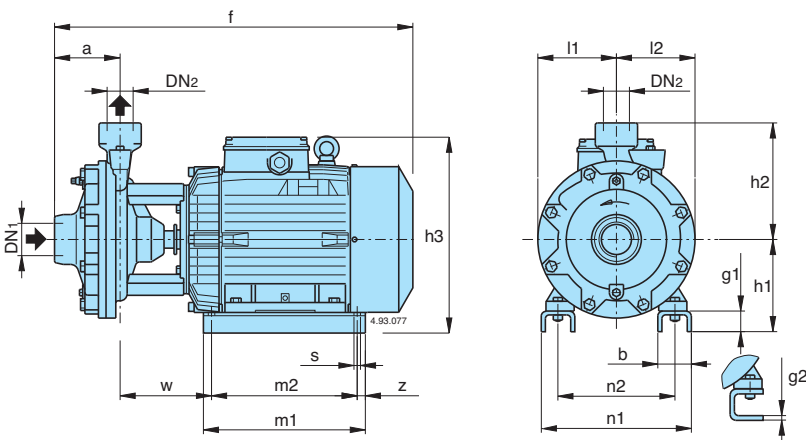

TYPE	NMD kg	B-NMD kg
B- NMD 32/210DE	60	66
B- NMD 32/210CE	70	76
B- NMD 32/210BE	76,5	82
B- NMD 32/210AE	99	105
B- NMD 40/180DE	59	65
B- NMD 40/180CE	69	75
B- NMD 40/180BE	75,5	81
B- NMD 40/180AE	97	102

B-NMD	NMD	DN1 ISO 228	DN2	mm																	
				a	f	h1	h2	h3	m1	m2	n1	n2	z	b	s	l	l1	l2	w	g1	g2
B- NMD 32/210DE	NMD 32/210DE	G 2	G 1 1/4	110	530	155	215	283	205	175	194	140		54	10	-	150	150	139	-	6
B- NMD 32/210BE-CE	NMD 32/210BE-CE			110	550	150	215	310	280	250	258	190	15	68	12	-	150	150	108	38	-
B- NMD 32/210AE	NMD 32/210AE			110	625	170	215	355	298	268	286	216		70	12	-	150	150	152	38	-
B- NMD 40/180DE	NMD 40/180DE	G 2	G 1 1/2	121	535	155	215	283	205	175	194	140		54	10	-	145	145	133	-	6
B- NMD 40/180BE-CE	NMD 40/180BE-CE			121	555	150	215	310	280	250	258	190	15	68	12	-	145	145	102	38	-
B- NMD 40/180CE	NMD 40/180CE			121	630	170	215	355	298	268	286	216		70	12	-	145	145	145	38	-
B- NMD 40/180AE	NMD 40/180AE			121	630	170	215	355	298	268	286	216		70	12	-	145	145	145	38	-